

Progetto: ARROTOLA MATERASSI

Commessa: BM183

Cliente: BROSIO

Disegnatore: FIB

Data: 14/05/2014

Tensione esercizio: 400V

Tensione ausiliari: 24VDC

Frequenza: 50HZ

Corrente nominale: 28A

Potenza totale: 19KW

Grado di protezione: IP55

FIB Srl

Forniture Industriali Brianza

Via Altobello 9/11

23848 OGGIONO (LC)

Tel. 0341 578960 - Fax 0341 263053

Rev.	Modifiche	Data	Preparato	Verificato	Approvato

CARATTERISTICHE QUADRO ELETTRICO
CONTROL PANEL SEATURES
CARACTERISTIQUES ARMOIRE ELETRIQUE
SCHALTSHRANKMERKMALE

FIB	Srl Forniture Industriali Brianza Via Altobello 9/11 23848 OGGIONO (LC) Tel. 0341 578960 - Fax 0341 263053		
COMMESSA	BM183	DATA	14/05/2014
PROGETTO	ARROTOLA MATERASSI		
POTENZA TOTALE	19KW		28A
TEN. ESERCIZIO	400V		
TEN. AUSILIARI	24VDC		
FREQUENZA	50HZ		IP55

REV.	DATA	FIRMA	MODIFICA

FIB Srl **Forniture Industriali Brianza**
 Via Altobello 9/11
 23848 OGGIONO (LC)
 Tel. 0341 578960 - Fax 0341 263053

PROGETTO: ARROTOLA MATERASSI	
CLIENTE: BROSIO	
COMMESSA: BM183	
TITOLO: Targa identificazione quadro	
DIS.: FIB	DATA: 14/05/2014

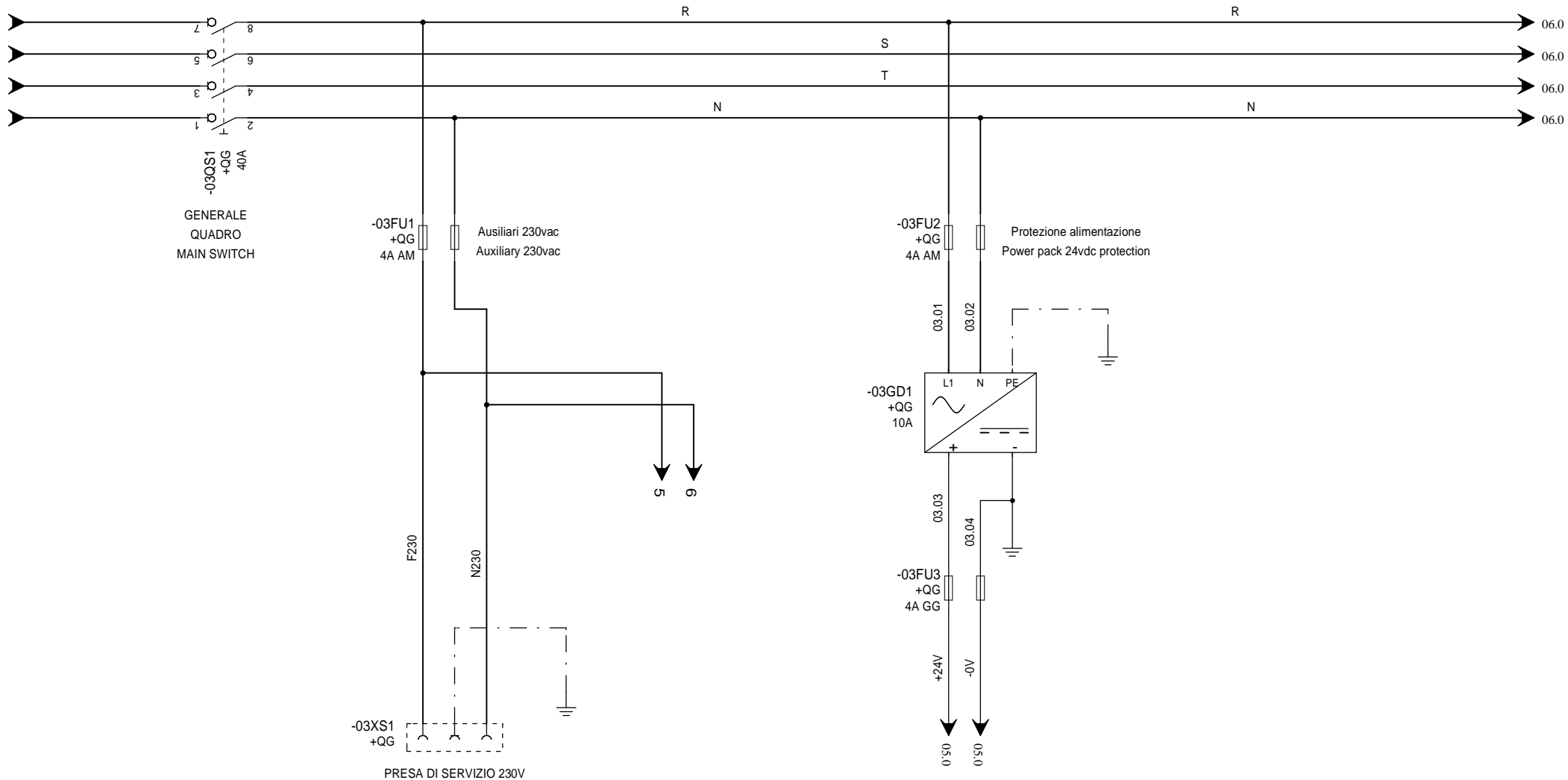

REV.	DATA	FIRMA	MODIFICA

FIB Srl **Forniture Industriali Brianza**
 Via Altobello 9/11
 23848 OGGIONO (LC)
 Tel. 0341 578960 - Fax 0341 263053

PROGETTO: ARROTOLA MATERASSI	
CLIENTE: BROSIO	
COMMESSA: BM183	
TITOLO: Potenza	
DIS.: FIB	DATA: 14/05/2014

FOGLIO 03
DI 33
02 ◀ ▶ 04

REV.	DATA	FIRMA	MODIFICA

FIB Srl **Forniture Industriali Brianza**
 Via Altobello 9/11
 23848 OGGIONO (LC)
 Tel. 0341 578960 - Fax 0341 263053

PROGETTO: ARROTOLA MATERASSI	
CLIENTE: BROSIO	
COMMESSA: BM183	
TITOLO: Disponibile	
DIS.: FIB	DATA: 14/05/2014

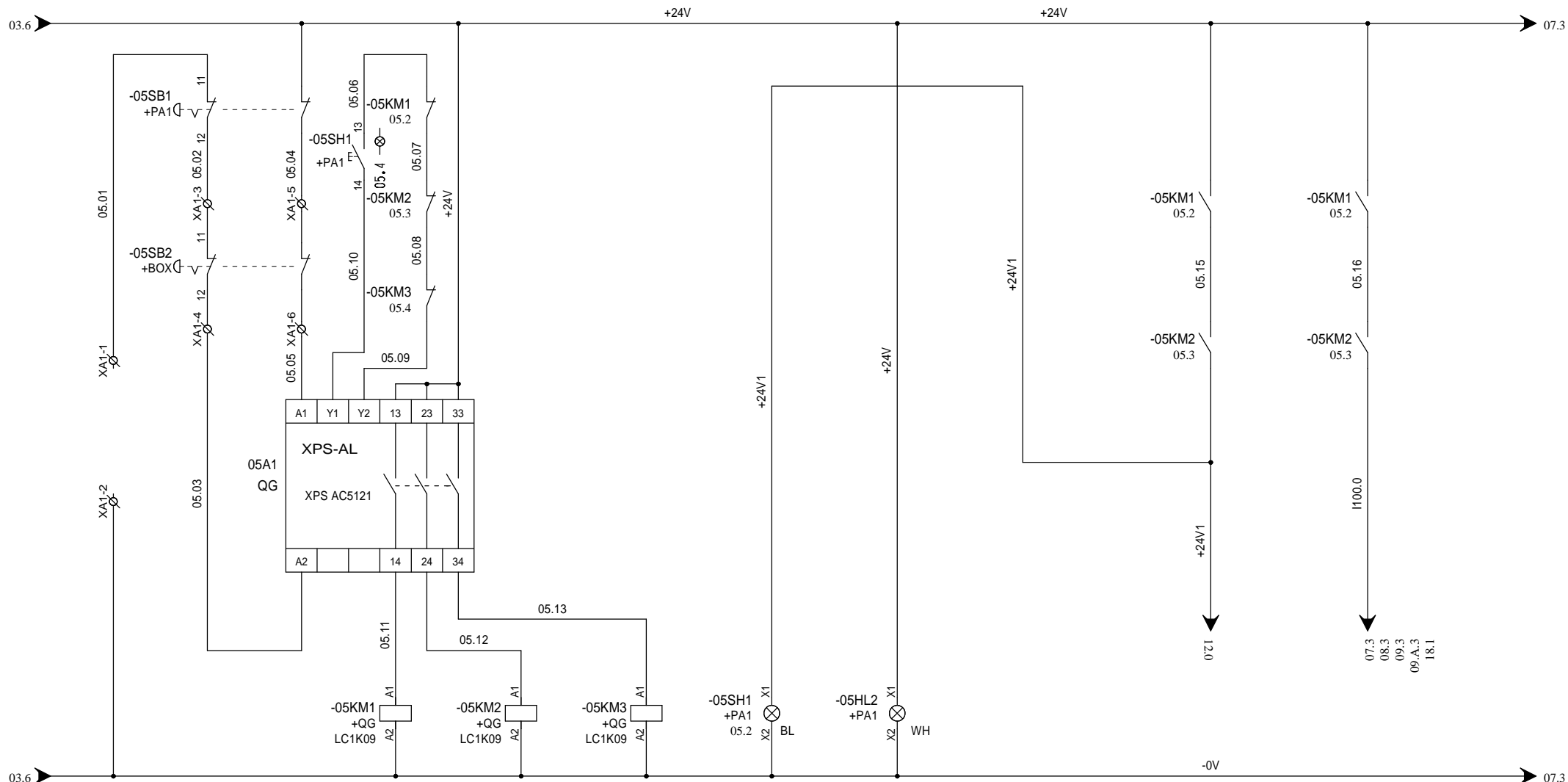

RELE' DI EMERGENZA 1 RELE' DI EMERGENZA 2 RELE' DI EMERGENZA 3 PULSANTE PRESENZA
 MERGYENCY RELAY 1 MERGYENCY RELAY 2 MERGYENCY RELAY 3 DI RESET TENSIONE

7	05.2	7	05.2	7	05.2
7	05.7	7	05.7	7	06.5
7	05.8	7	05.8	7	06.5
				7	06.5

REV.	DATA	FIRMA	MODIFICA

FIB Srl **Forniture Industriali Brianza**
 Via Altobello 9/11
 23848 OGGIONO (LC)
 Tel. 0341 578960 - Fax 0341 263053

PROGETTO: ARROTOLA MATERASSI	
CLIENTE: BROSIO	
COMMESSA: BM183	
TITOLO: Circuito di sicurezza emergenza Emergency safety circuit	
DIS.: FIB	DATA: 14/05/2014

FOGLIO 05
 DI 33
 04 ◀ ▶ 06

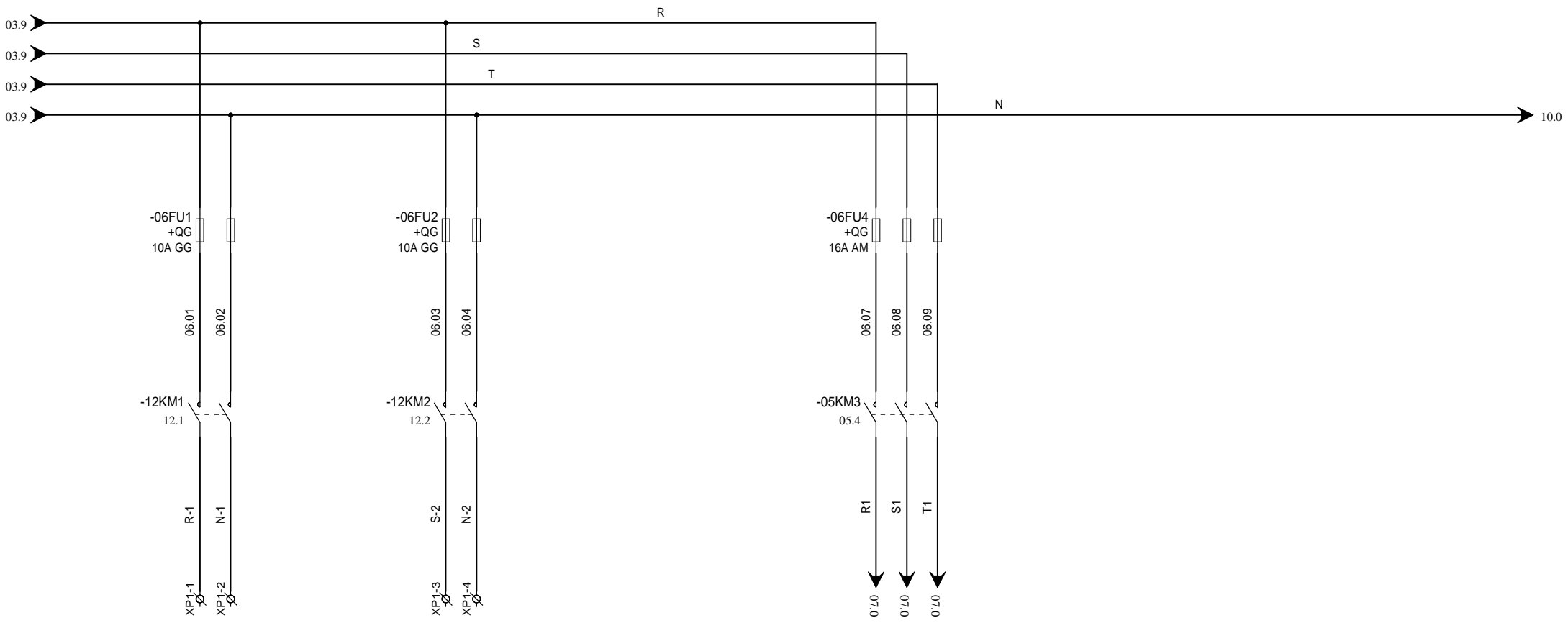

REV.	DATA	FIRMA	MODIFICA

FIB Srl **Forniture Industriali Brianza**
 Via Altobello 9/11
 23848 OGGIONO (LC)
 Tel. 0341 578960 - Fax 0341 263053

PROGETTO: ARROTOLA MATERASSI	
CLIENTE: BROSIO	
COMMESSA: BM183	
TITOLO: Riscaldatori + linea motori electric heater + motors supply	
DIS.: FIB	DATA: 14/05/2014

FOGLIO 06
DI 33
05 ◀ ▶ 07

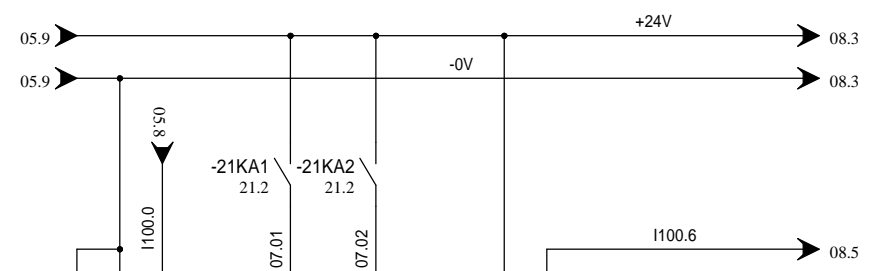
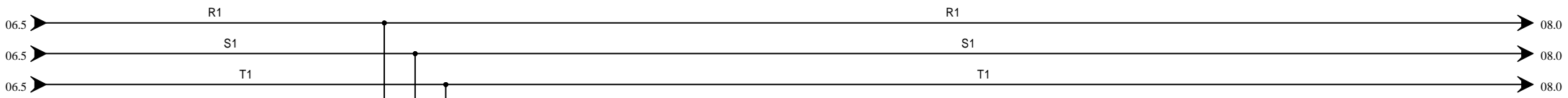

07A1
QG

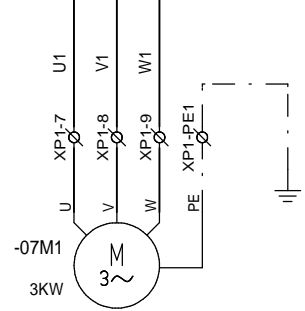
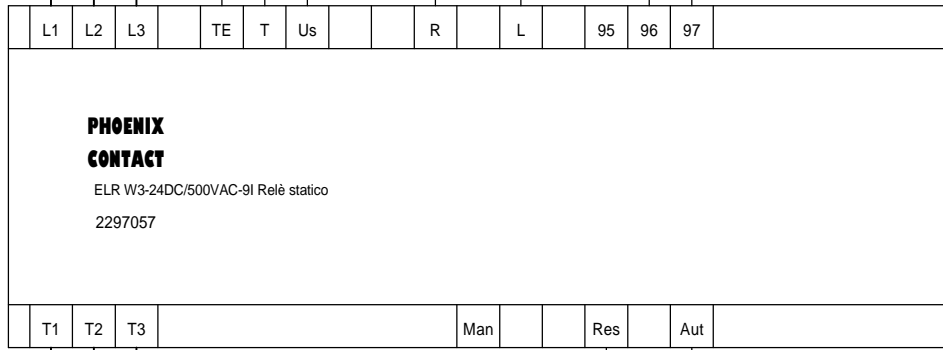

MOTORE ROTAZIONE CILINDRO
CILINDER ROTATION MOTOR

REV.	DATA	FIRMA	MODIFICA

FIB Srl **Forniture Industriali Brianza**
 Via Altobello 9/11
 23848 OGGIONO (LC)
 Tel. 0341 578960 - Fax 0341 263053

PROGETTO: ARROTOLA MATERASSI	
CLIENTE: BROSIO	
COMMESSA: BM183	
TITOLO: Motore rotazione cilindro Cilinder rotation motor	
DIS.: FIB	DATA: 14/05/2014

FOGLIO 07
DI 33
06 ◀ ▶ 08

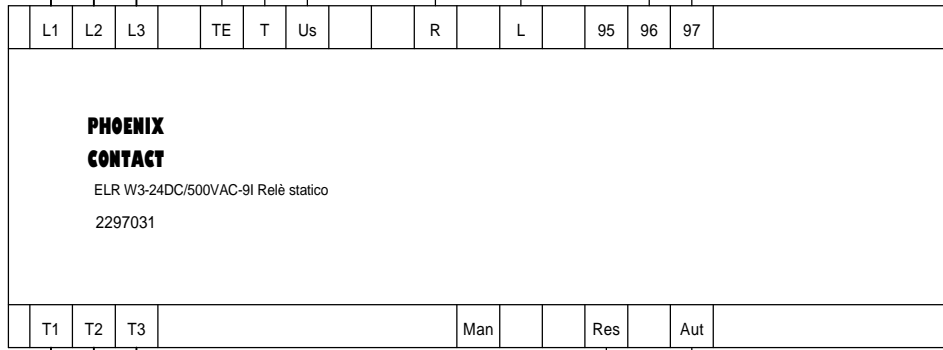
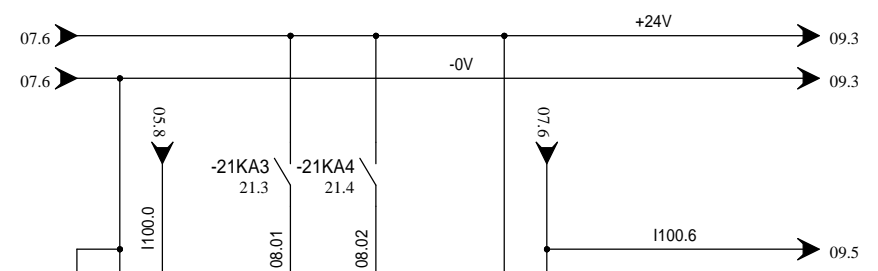
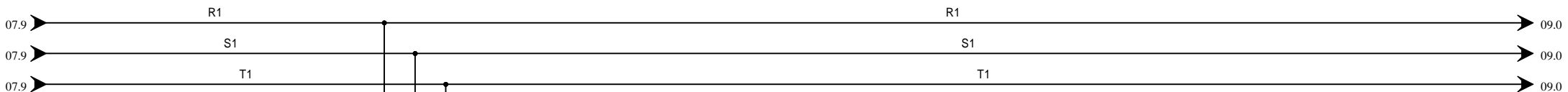

08A1
QG

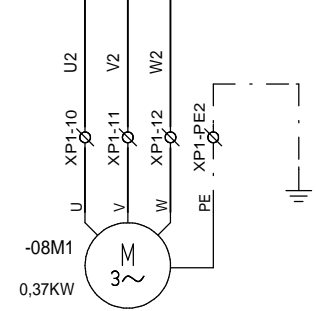

MOTORE ESPULSIONE CILINDRO
CILINDER EJECTION ROTATION

REV.	DATA	FIRMA	MODIFICA

FIB Srl **Forniture Industriali Brianza**
Via Altobello 9/11
23848 OGGIONO (LC)
Tel. 0341 578960 - Fax 0341 263053

PROGETTO: ARROTOLA MATERASSI	
CLIENTE: BROSIO	
COMMESSA: BM183	
TITOLO: Motore carrello esp. cilindro Cilinder ejection motor	
DIS.: FIB	DATA: 14/05/2014

FOGLIO 08
DI 33
07 ◀ ▶ 09

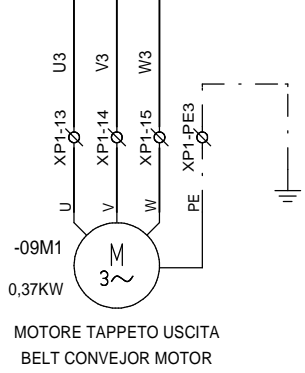
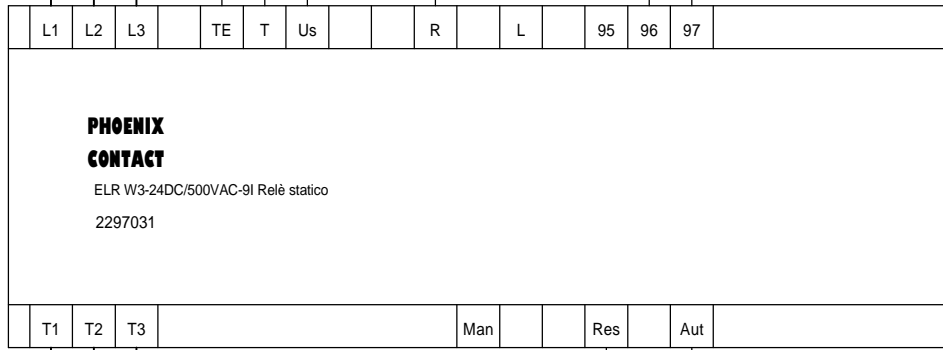
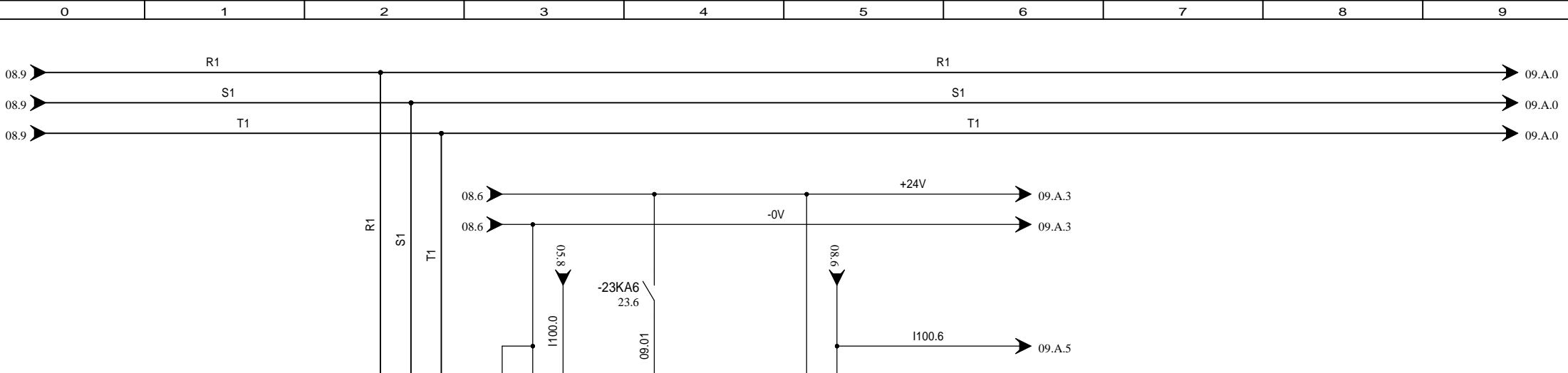

REV.	DATA	FIRMA	MODIFICA

FIB Srl **Forniture Industriali Brianza**
 Via Altobello 9/11
 23848 OGGIONO (LC)
 Tel. 0341 578960 - Fax 0341 263053

PROGETTO: ARROTOLA MATERASSI	
CLIENTE: BROSIO	
COMMESSA: BM183	
TITOLO: Motore tappeto uscita Belt conveyor motor	
DIS.: FIB	DATA: 14/05/2014

FOGLIO 09
 DI 33
 08 ◀ ▶ 09.A

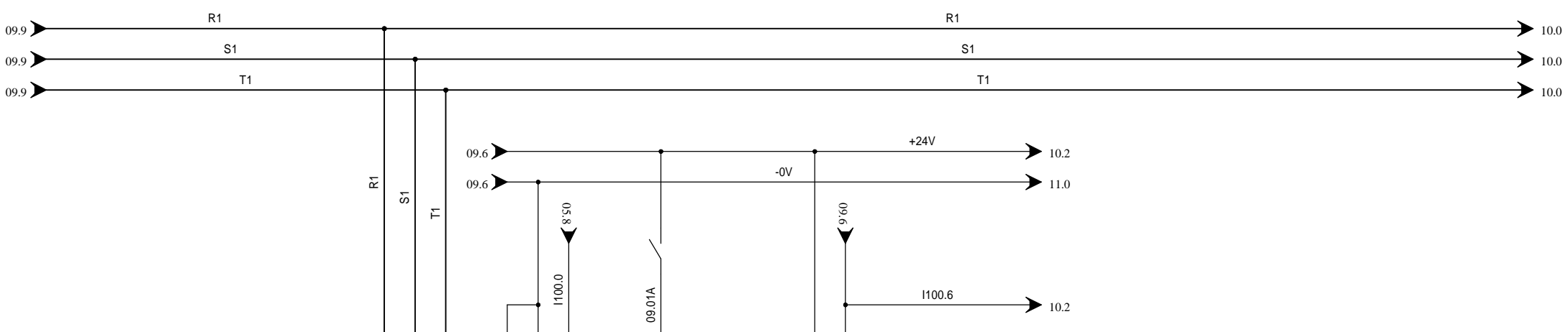

09A2
QG

PHOENIX CONTACT
ELR W3-24DC/500VAC-9I Relè statico
2297031

L1	L2	L3	TE	T	Us		R	L	95	96	97
T1	T2	T3		Man			Res		Aut		

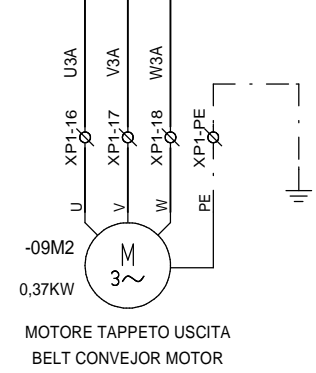

REV.	DATA	FIRMA	MODIFICA

FIB Srl **Forniture Industriali Brianza**
Via Altobello 9/11
23848 OGGIONO (LC)
Tel. 0341 578960 - Fax 0341 263053

PROGETTO: ARROTOLA MATERASSI	
CLIENTE: BROSIO	
COMMESSA: BM183	
TITOLO: Motore tappeto uscita Belt conveyor motor	
DIS.: FIB	DATA: 14/05/2014

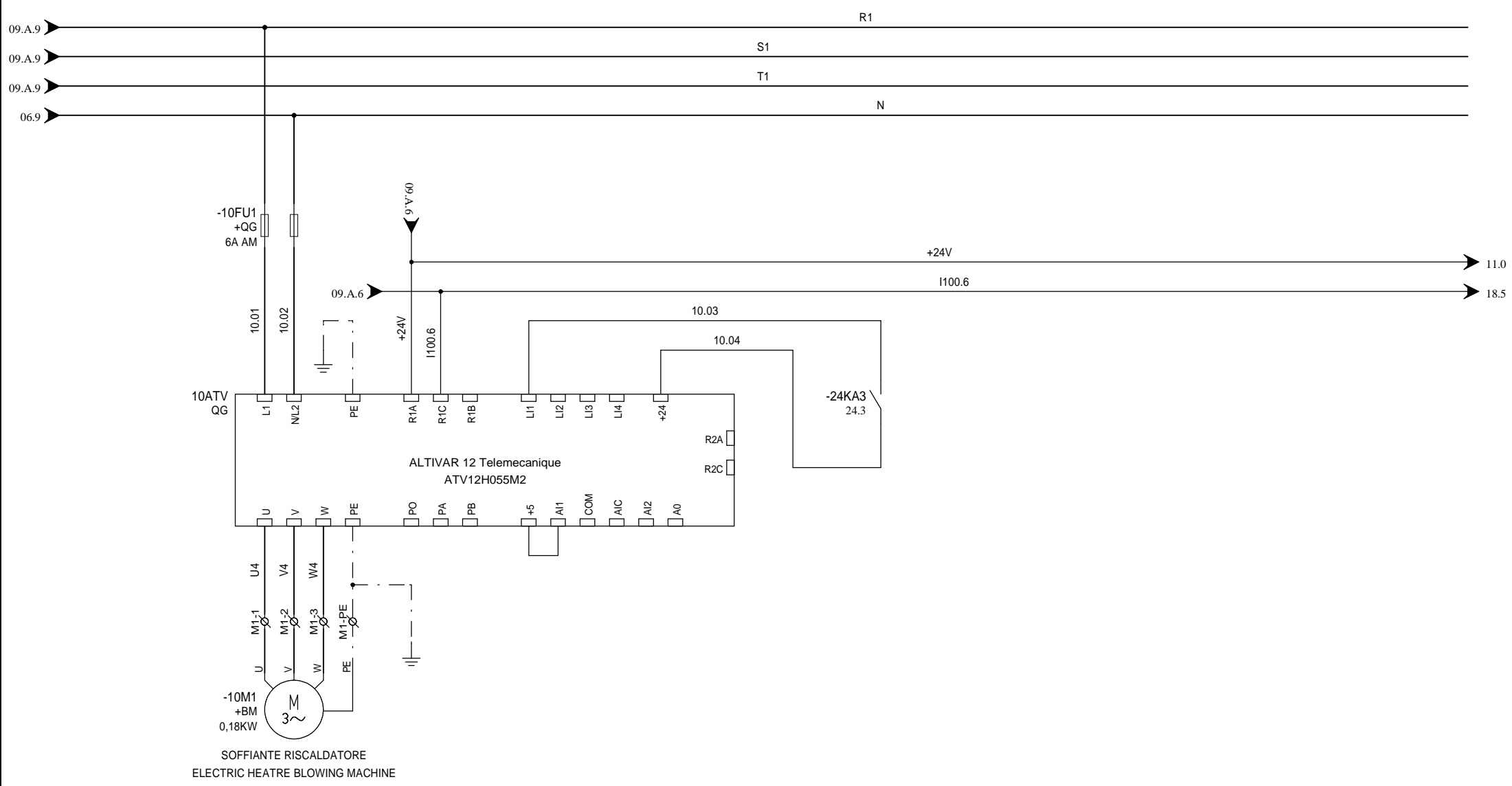

REV.	DATA	FIRMA	MODIFICA

FIB Srl **Forniture Industriali Brianza**
 Via Altobello 9/11
 23848 OGGIONO (LC)
 Tel. 0341 578960 - Fax 0341 263053

PROGETTO: ARROTOLA MATERASSI	
CLIENTE: BROSIO	
COMMESSA: BM183	
TITOLO: Soffiante riscaldatore electric heater blowing machine	
DIS.: FIB	DATA: 14/05/2014

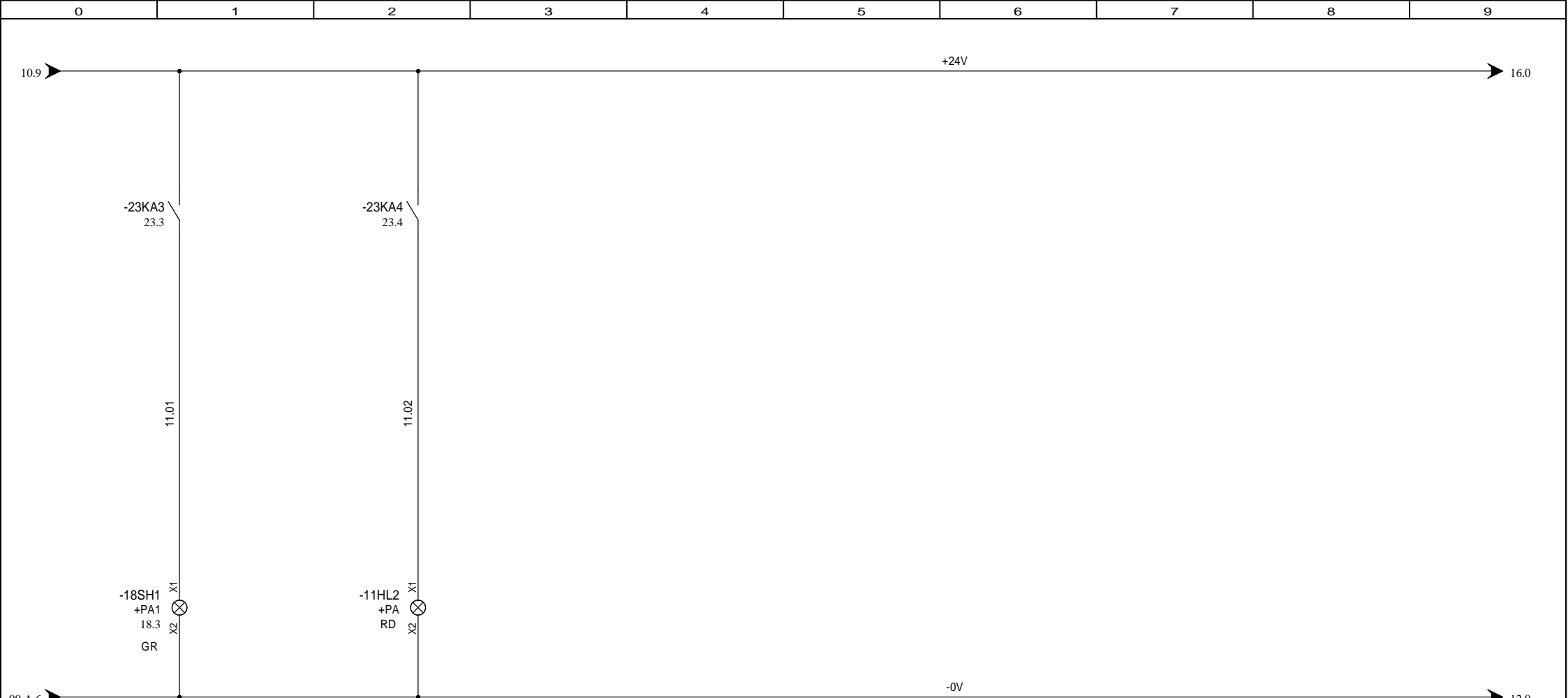

LAMPADA CICLO
CICLE LIGHTING LAMP

LAMPADA ALLARMI
ALARM LIGHTING LAMP

REV.	DATA	FIRMA	MODIFICA

FIB Srl **Forniture Industriali Brianza**
Via Altobello 9/11
23848 OGGIONO (LC)
Tel. 0341 578960 - Fax 0341 263053

PROGETTO: ARROTOLA MATERASSI	
CLIENTE: BROSIO	
COMMESSA: BM183	
TITOLO: Ausiliari 24VDC Auxiliary 24 vdc	
DIS.: FIB	DATA: 14/05/2014

FOGLIO 11
DI 33
10◀▶12

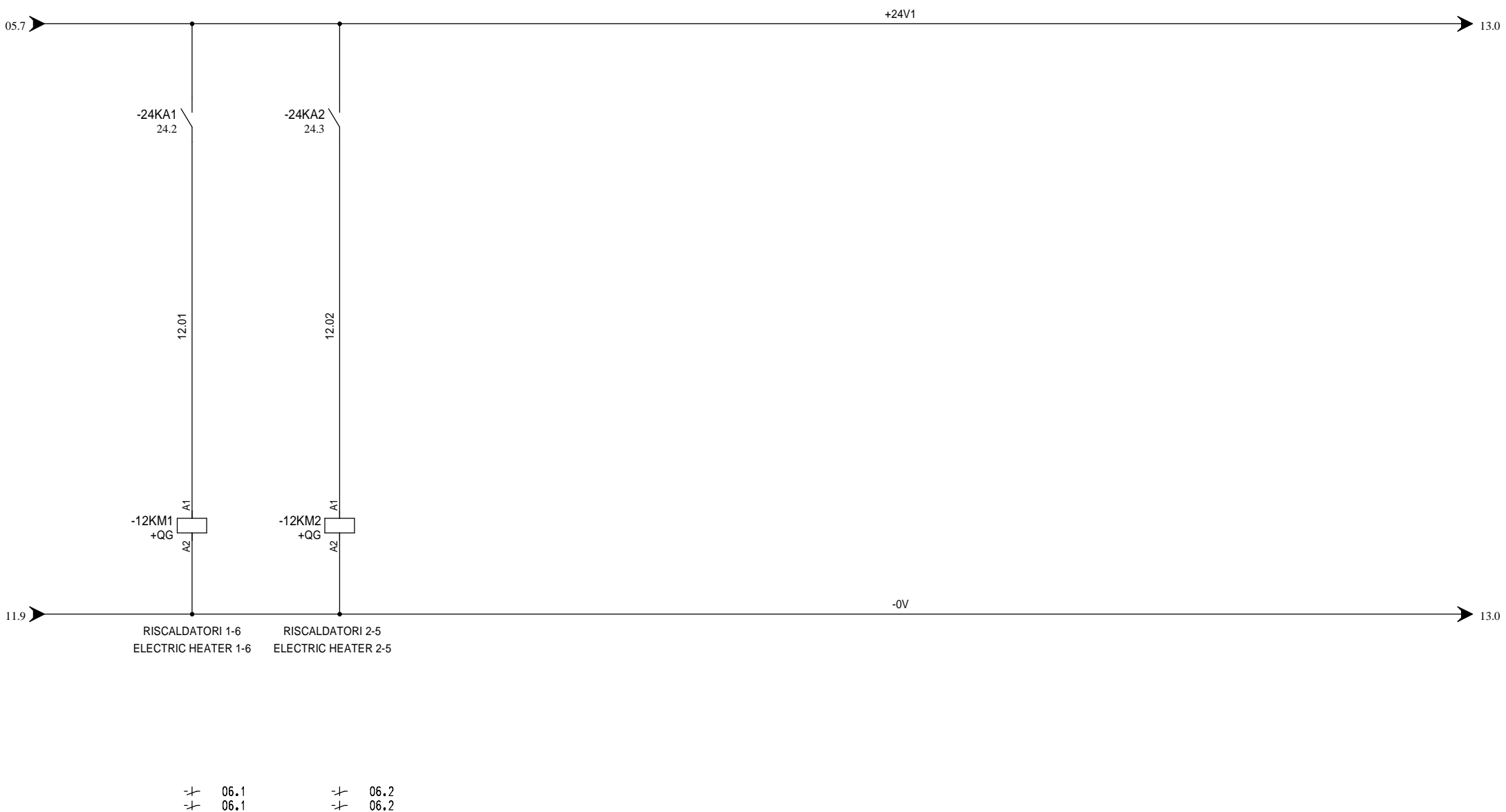

REV.	DATA	FIRMA	MODIFICA

FIB Srl **Forniture Industriali Brianza**
 Via Altobello 9/11
 23848 OGGIONO (LC)
 Tel. 0341 578960 - Fax 0341 263053

PROGETTO: ARROTOLA MATERASSI	
CLIENTE:	BROSIO
COMMESSA:	BM183
TITOLO:	Riscaldatori da 1-6 Electric heater from 1-6
DIS.: FIB	DATA: 14/05/2014

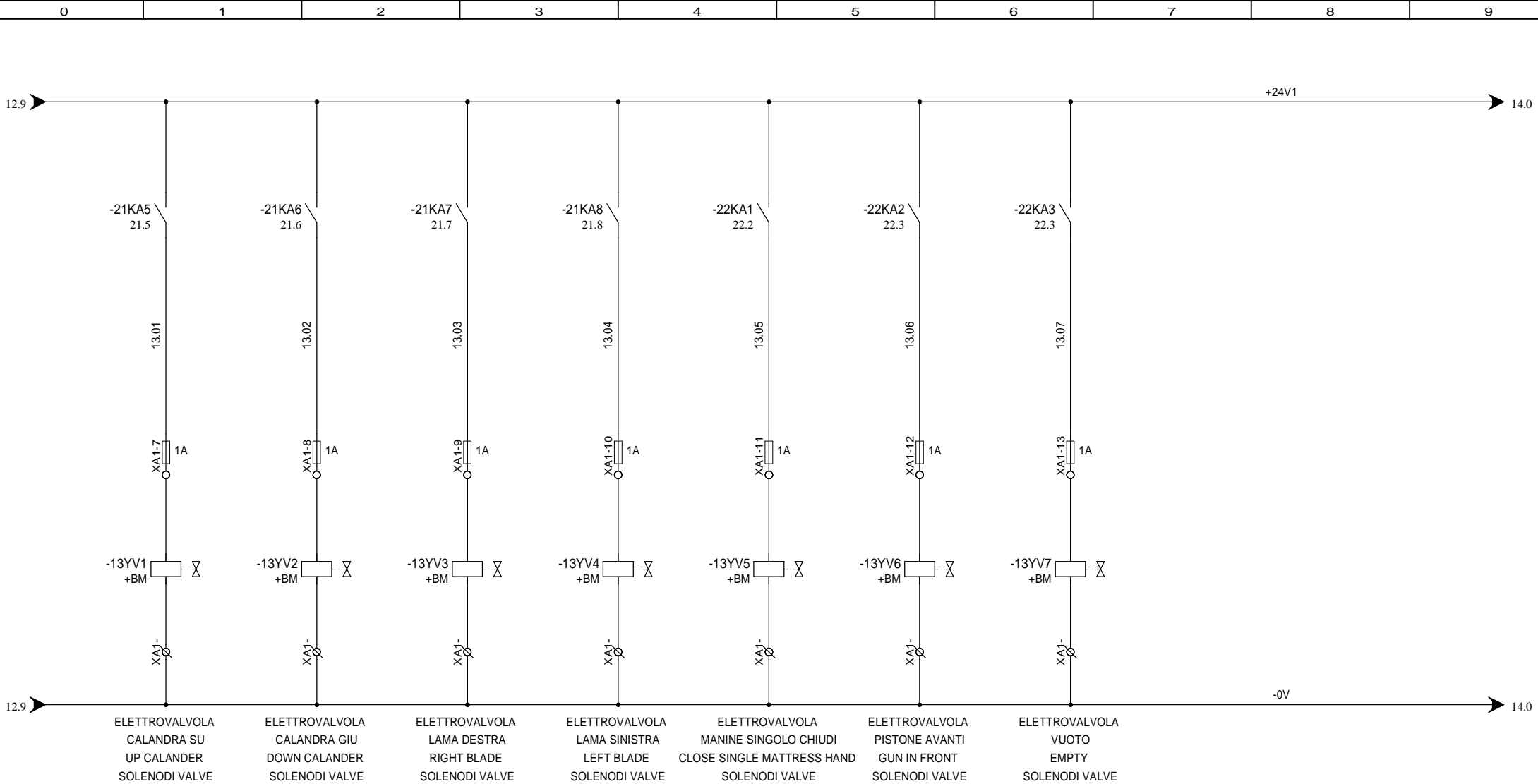

REV.	DATA	FIRMA	MODIFICA

FIB Srl **Forniture Industriali Brianza**
 Via Altobello 9/11
 23848 OGGIONO (LC)
 Tel. 0341 578960 - Fax 0341 263053

PROGETTO: ARROTOLA MATERASSI	
CLIENTE: BROSIO	
COMMESSA: BM183	
TITOLO: Elettrovalvole solenoid valve	
DIS.: FIB	DATA: 14/05/2014

FOGLIO 13
 DI 33
 12 ◀▶ 14

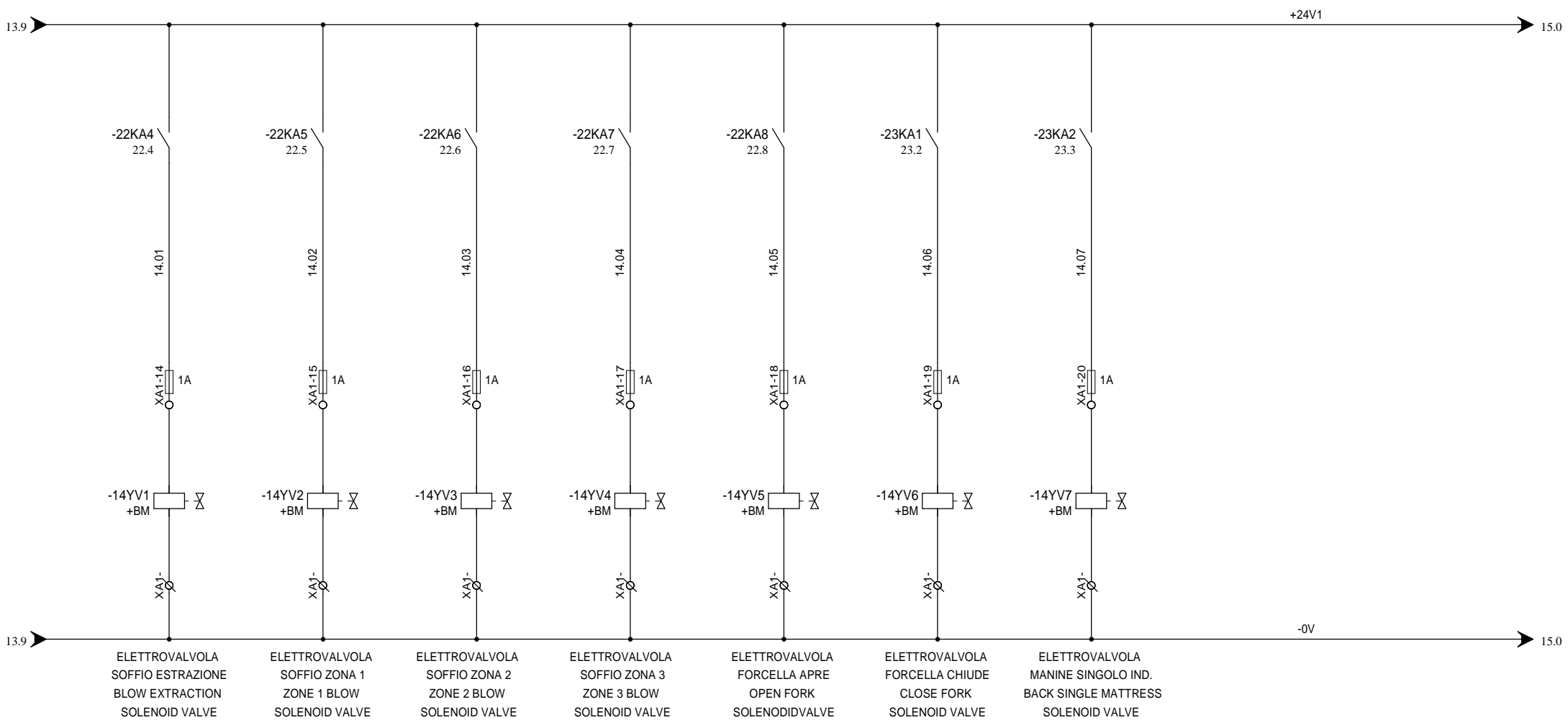

ELETTROVALVOLA
SOFFIO ESTRAZIONE
BLOW EXTRACTION
SOLENOID VALVE

ELETTROVALVOLA
SOFFIO ZONA 1
ZONE 1 BLOW
SOLENOID VALVE

ELETTROVALVOLA
SOFFIO ZONA 2
ZONE 2 BLOW
SOLENOID VALVE

ELETTROVALVOLA
SOFFIO ZONA 3
ZONE 3 BLOW
SOLENOID VALVE

ELETTROVALVOLA
FORCELLA APRE
OPEN FORK
SOLENOID VALVE

ELETTROVALVOLA
FORCELLA CHIUDE
CLOSE FORK
SOLENOID VALVE

ELETTROVALVOLA
MANINE SINGOLO IND.
BACK SINGLE MATTRESS
SOLENOID VALVE

REV.	DATA	FIRMA	MODIFICA

FIB Srl **Forniture Industriali Brianza**
Via Altobello 9/11
23848 OGGIONO (LC)
Tel. 0341 578960 - Fax 0341 263053

PROGETTO: ARROTOLA MATERASSI	
CLIENTE: BROSIO	
COMMESSA: BM183	
TITOLO: Elettrovalvole solenoid valve	
DIS.: FIB	DATA: 14/05/2014

FOGLIO 14
DI 33
13 ◀▶ 15

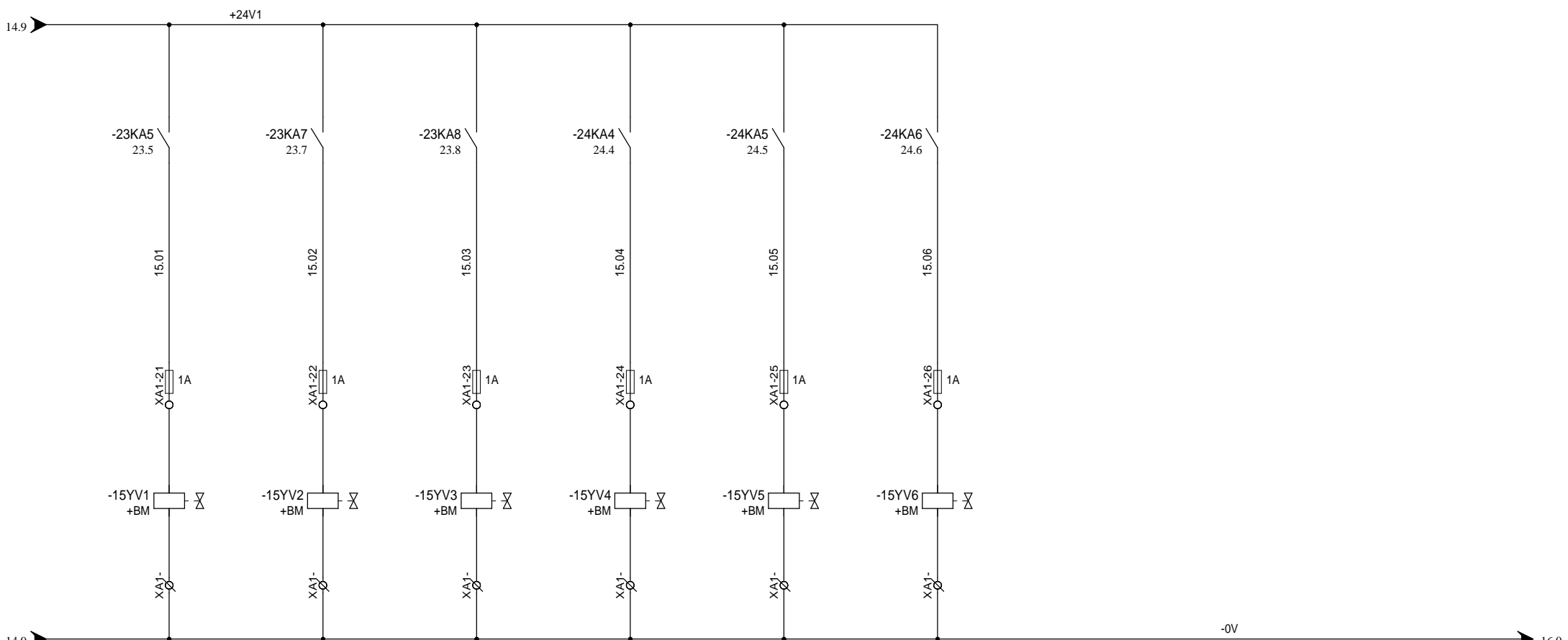

ELETTROVALVOLA MANINE MATRIMONIALE CH. CLOSE DOUBLE MATTRESS HAND SOLENOID VALVE	ELETTROVALVOLA MANINE MATRIMONIALE IND. BACK DOUBLE MATTRESS HAND SOLENOID VALVE	ELETTROVALVOLA SCARICO MATERASSO DROP MATTRESS SOLENOID VALVE	ELETTROVALVOLA BLOCCO FILM STOP FILM SOLENOID VALVE	ELETTROVALVOLA SOFFIO FILM FILM BLOW SOLENOID VALVE	ELETTROVALVOLA CHIUSURA CALANDRA INGR. CLOSE ENTRANCE CALEND. SOLENOID VALVE
---	---	--	--	--	---

REV.	DATA	FIRMA	MODIFICA

FIB Srl **Forniture Industriali Brianza**
 Via Altobello 9/11
 23848 OGGIONO (LC)
 Tel. 0341 578960 - Fax 0341 263053

PROGETTO: ARROTOLA MATERASSI	
CLIENTE: BROSIO	
COMMESSA: BM183	
TITOLO: Elettrovalvole solenoid valve	
DIS.: FIB	DATA: 14/05/2014

PIN 2 - GREEN
 PIN 3 - WHITE
 PIN 7 - BROWN
 PIN 4 BRIDGE PIN 5

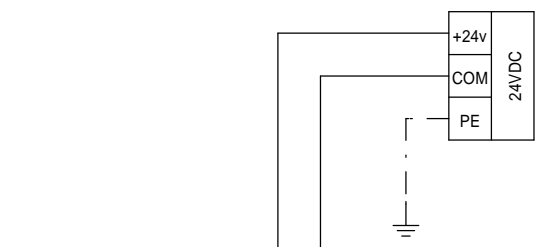
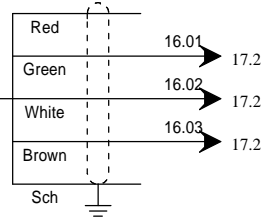
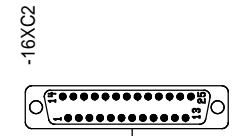
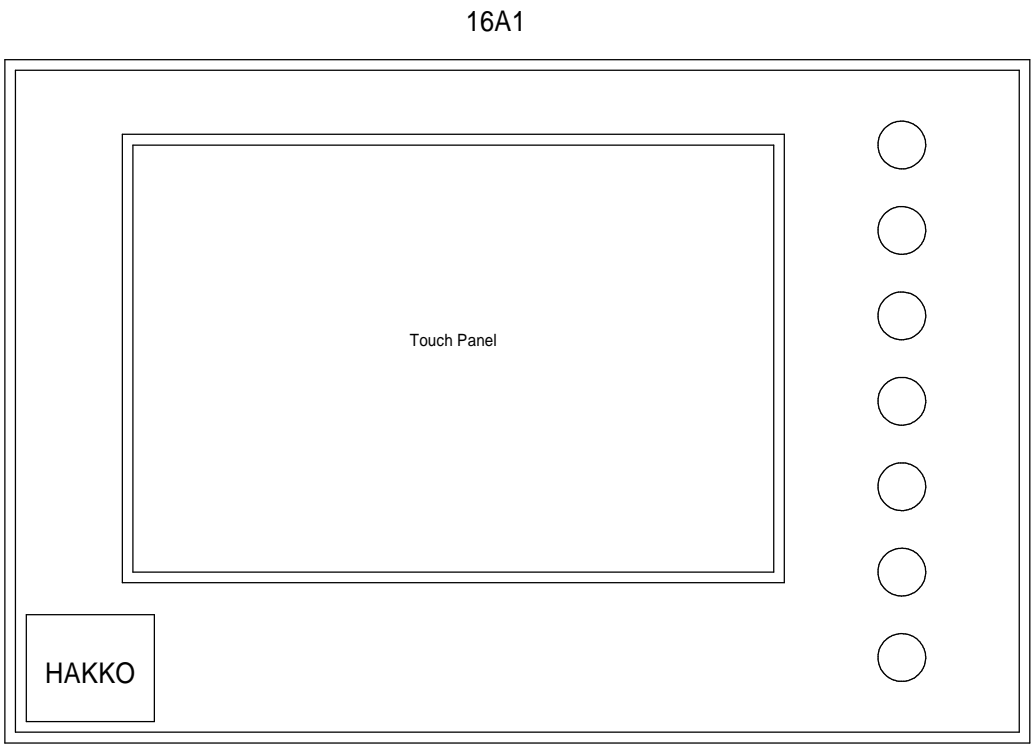
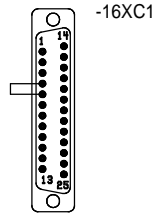

HAKKO - V606EM20
 Pannello operatore
 Operator Panel

REV.	DATA	FIRMA	MODIFICA

FIB Srl **Forniture Industriali Brianza**
 Via Altobello 9/11
 23848 OGGIONO (LC)
 Tel. 0341 578960 - Fax 0341 263053

PROGETTO: ARROTOLA MATERASSI	
CLIENTE: BROSIO	
COMMESSA: BM183	
TITOLO: Pannello operatore Operator panel	
DIS.: FIB	DATA: 14/05/2014

FOGLIO 16
 DI 33
 15 ◀▶ 17

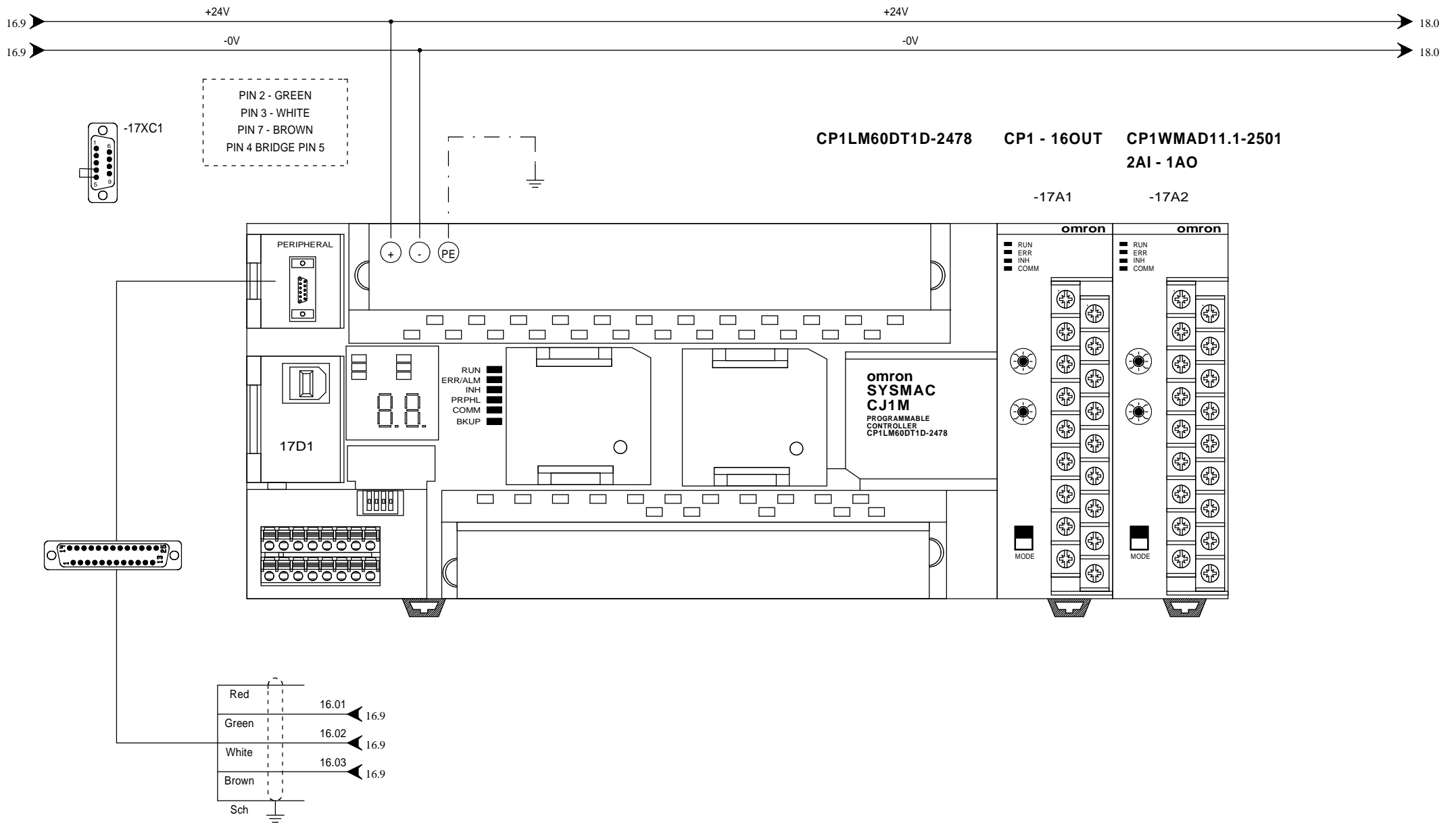

REV.	DATA	FIRMA	MODIFICA

FIB Srl **Forniture Industriali Brianza**
Via Altobello 9/11
23848 OGGIONO (LC)
Tel. 0341 578960 - Fax 0341 263053

PROGETTO: ARROTOLA MATERASSI	FOGLIO 17
CLIENTE: BROSIO	DI 33
COMMESSA: BM183	
TITOLO: Plc Rack Rack Plc	16 ◀▶ 18
DIS.: FIB	DATA: 14/05/2014

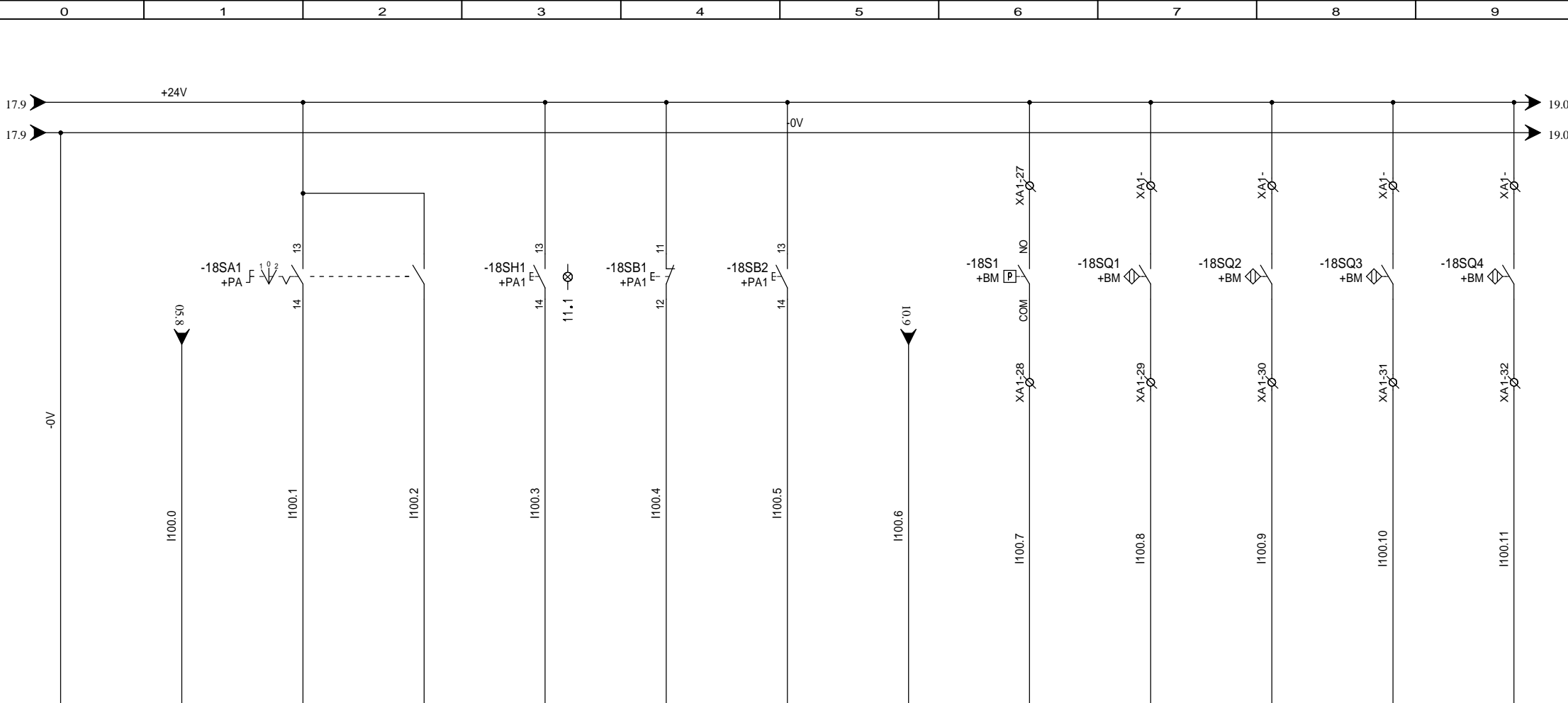

COM	I100.0	I100.1	I100.2	I100.3	I100.4	I100.5	I100.6	I100.7	I100.8	I100.9	I100.10	I100.11
OMRON SYSTEMC CP1LM60DT1D	Consenso relè emergenza	Selettore manuale Manual mode	Selettore automatico Automatic mode	Start ciclo Cycle start	Stop ciclo Cycle stop	Reset allarmi Reset alarm	Scatto termico cumulativo Cumulative thermal trip	Pressostato aria Air pressure switch	F.c. calandra chiusa Close calander limit switch	F.c. calandra aperta Open calander limit switch	F.c. forcella aperta Open fork limit switch	F.c. forcella chiusa Close fork limit switch
OMRON 17D1	Emergency on relay enable	Manual mode	Automatic mode	Cycle start	Cycle stop	Reset alarm	Cumulative thermal trip	Air pressure switch	Close calander limit switch	Open calander limit switch	Open fork limit switch	Close fork limit switch

REV.	DATA	FIRMA	MODIFICA

FIB Srl **Forniture Industriali Brianza**
 Via Altobello 9/11
 23848 OGGIONO (LC)
 Tel. 0341 578960 - Fax 0341 263053

PROGETTO: ARROTOLA MATERASSI	
CLIENTE: BROSIO	
COMMESSA: BM183	
TITOLO: Ingressi e uscite In Out	
DIS.: FIB	DATA: 14/05/2014

FOGLIO **18**
 DI **33**
17 ◀ ▶ **19**

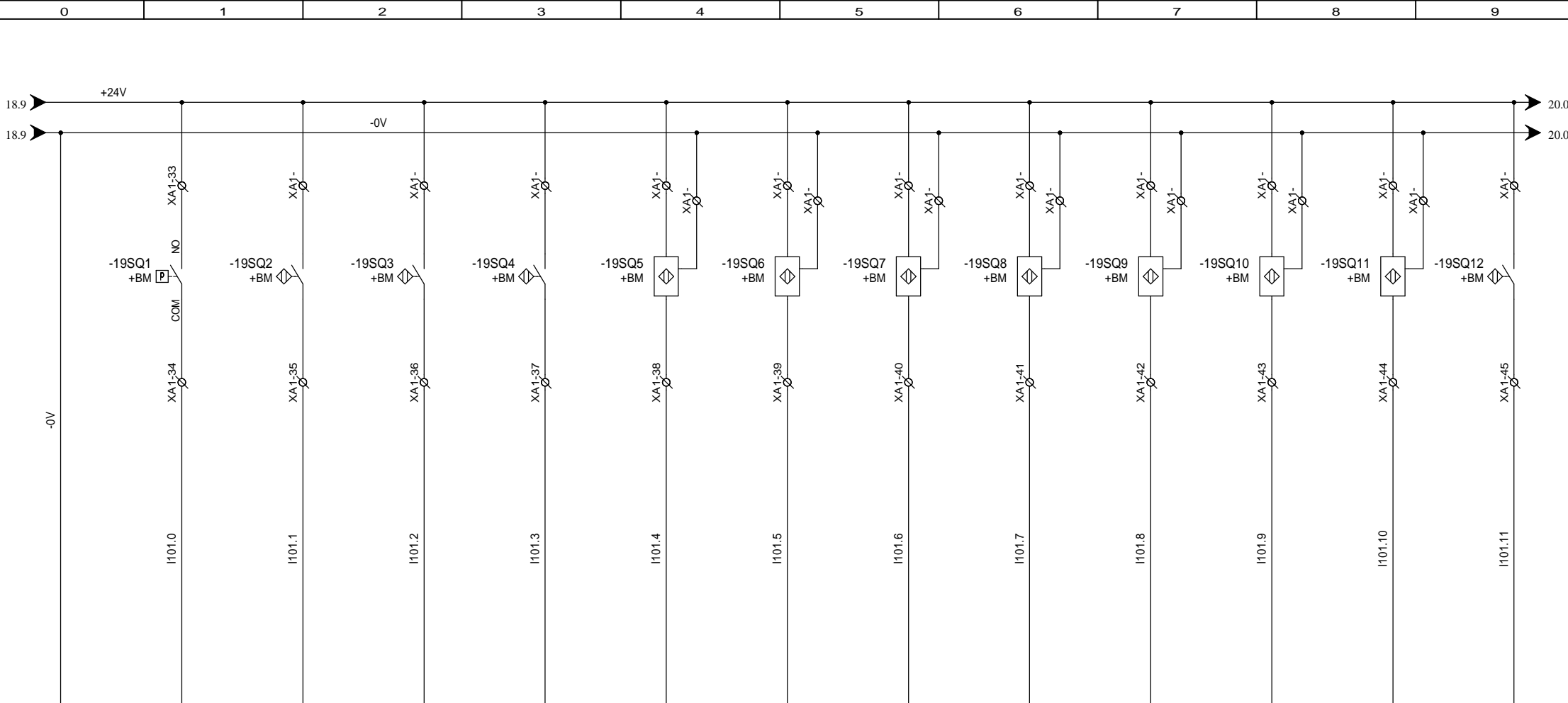

COM	I101.0	I101.1	I101.2	I101.3	I101.4	I101.5	I101.6	I101.7	I101.8	I101.9	I101.10	I101.11
OMRON SYSTEMC CP1LM60DT1D	Fc manine singolo avanti	Fc manine singolo indietro	Fc manine matrimoniale avanti	Fc manine matrimoniale ind.	Fc espulsore dentro Ejector in limit switch	Fc espulsore zona 1 ejector zone 1 limit switch	Fc espulsore zona 2 ejector zone 2 limit switch	Fc espulsore zona 3 ejector zone 3 limit switch	Fc espulsore fuori ejector out limit switch	FT controllo diametro Checking diameter photocell	FT controllo materasso mattress entrance photocell	Fc lama destra Right blade limit switch
OMRON 17D1	single mattress hand in front limit switch	single mattress hand in back limit switch	double mattress hand in front limit switch	double mattress hand in back limit switch	Ejector in limit switch	ejector zone 1 limit switch	ejector zone 2 limit switch	ejector zone 3 limit switch	ejector out limit switch	Checking diameter photocell	mattress entrance photocell	Right blade limit switch

REV.	DATA	FIRMA	MODIFICA

FIB Srl **Forniture Industriali Brianza**
 Via Altobello 9/11
 23848 OGGIONO (LC)
 Tel. 0341 578960 - Fax 0341 263053

PROGETTO: ARROTOLA MATERASSI		FOGLIO 19
CLIENTE: BROSIO		DI 33
COMMESSA: BM183		18 ◀▶ 20
TITOLO: Ingressi e uscite In Out		
DIS: FIB		DATA: 14/05/2014

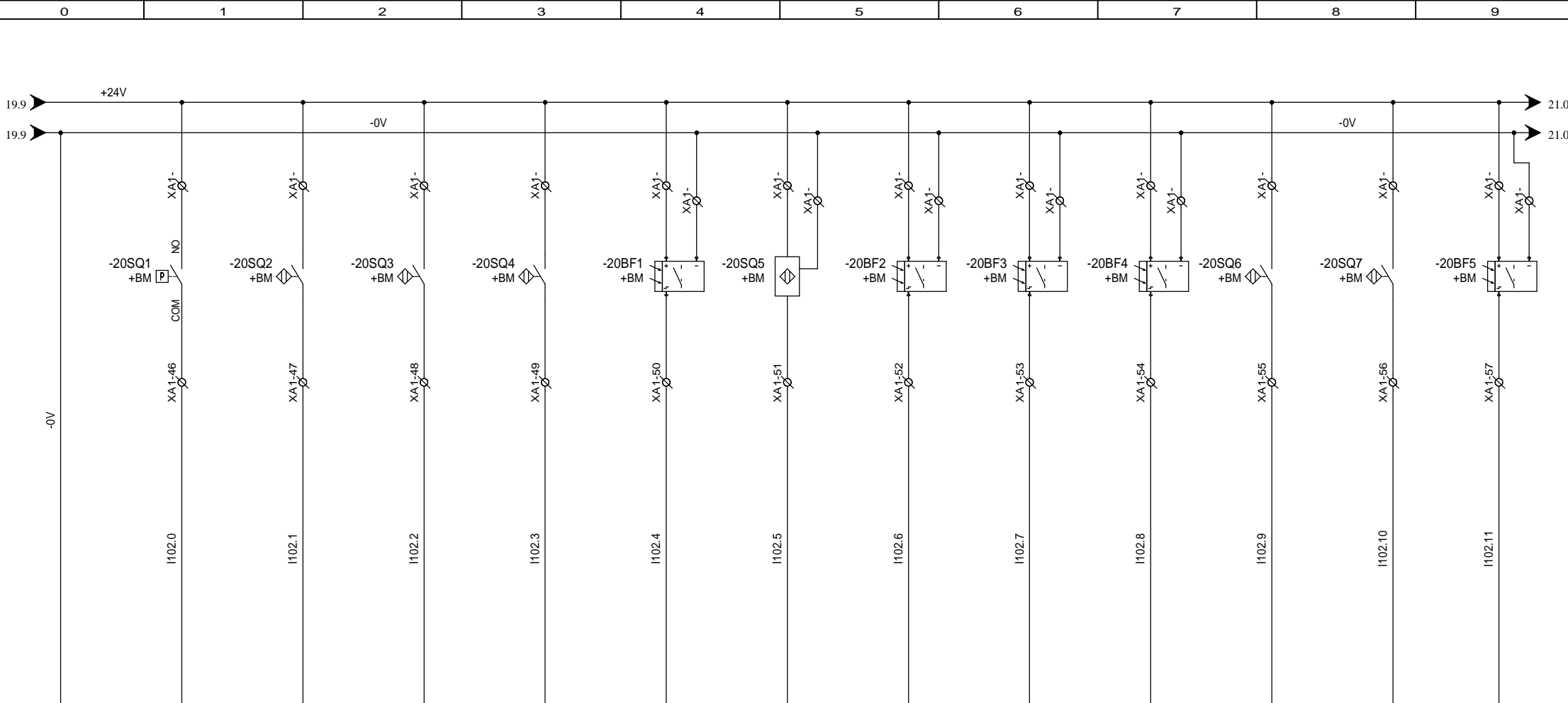

COM	I102.0	I102.1	I102.2	I102.3	I102.4	I102.5	I102.6	I102.7	I102.8	I102.9	I102.10	I102.11
OMRON SYSTEMC CP1LM60DT1D	Fc lama sinistra Left blade limit switch	FC pistola indietro Gun back limit switch	FC pistola avanti Gun in front limit switch	Fc stop calandra intermedia Stop middle calander limit switch	FT uscita materasso Mattress exit photocell	Fc rotazione mandrino Spindle rotation limit switch	FT riconoscimento materasso matrim. Identification double mattress P.C.	FT fine velo superiore Top film ending photocell	FT fine velo inferiore Bottom film ending photocell	F.C. cilindro espulsore fuori Ejection out limit switch	F.C. cilindro espulsore dentro Ejection in limit switch	FT scatola in posizione Box in position limit switch
OMRON 17D1												

REV.	DATA	FIRMA	MODIFICA

FIB Srl **Forniture Industriali Brianza**
 Via Altobello 9/11
 23848 OGGIONO (LC)
 Tel. 0341 578960 - Fax 0341 263053

PROGETTO: ARROTOLA MATERASSI	
CLIENTE: BROSIO	
COMMESSA: BM183	
TITOLO: Ingressi e uscite In Out	
DIS: FIB	DATA: 14/05/2014

FOGLIO 20
 DI 33
 19 ◀▶ 21

Omron

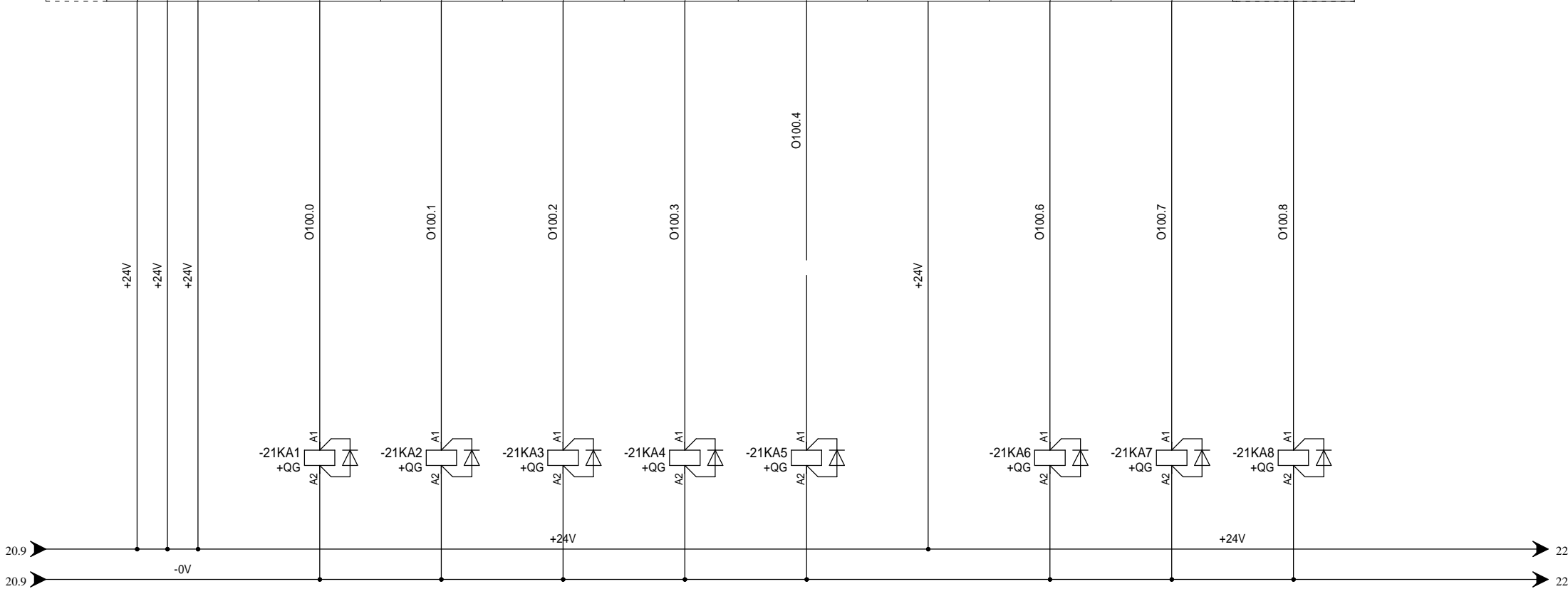
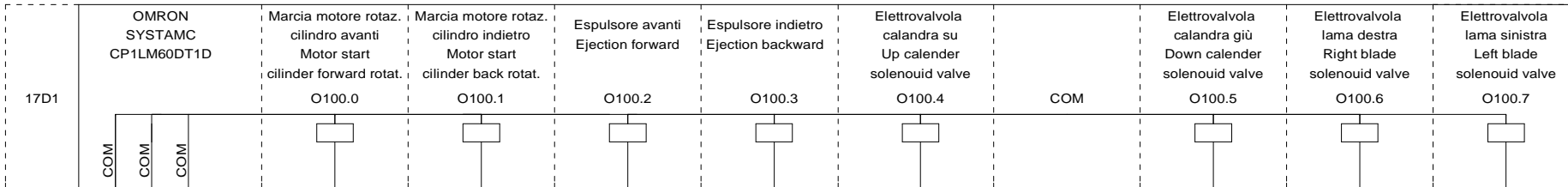

07.4 07.4 08.4 08.4 13.1 13.2 13.3 13.4

REV.	DATA	FIRMA	MODIFICA

FIB Srl **Forniture Industriali Brianza**
 Via Altobello 9/11
 23848 OGGIONO (LC)
 Tel. 0341 578960 - Fax 0341 263053

PROGETTO: ARROTOLA MATERASSI	
CLIENTE: BROSIO	
COMMESSA: BM183	
TITOLO: Ingressi e uscite In Out	
DIS.: FIB	DATA: 14/05/2014

FOGLIO 21
 DI 33
 20 ◀▶ 22

Omron

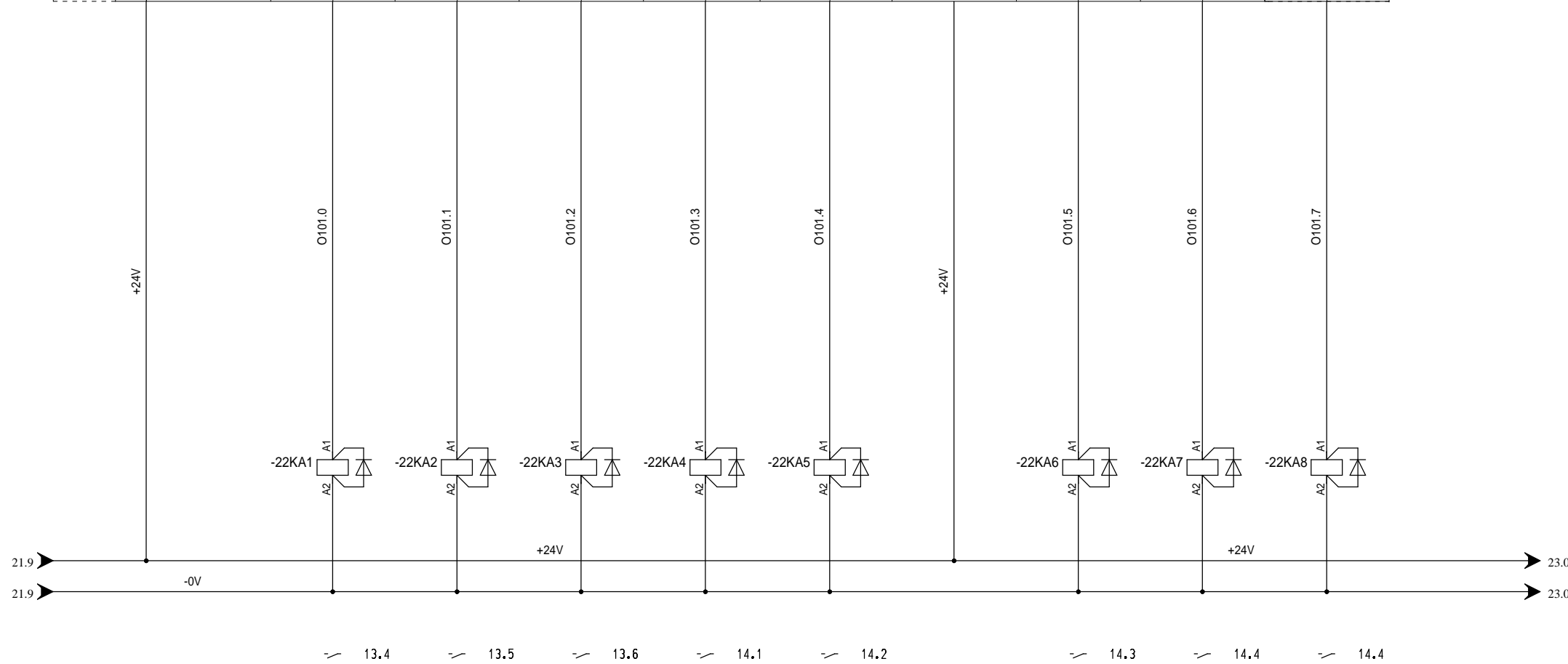
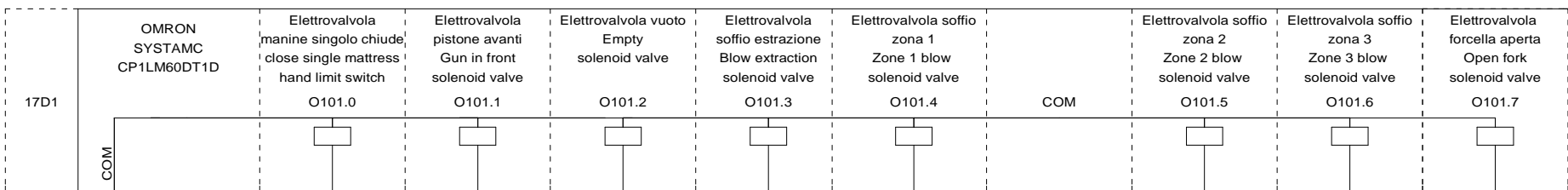

13.4 13.5 13.6 14.1 14.2 14.3 14.4 14.4

REV.	DATA	FIRMA	MODIFICA

FIB Srl **Forniture Industriali Brianza**
 Via Altobello 9/11
 23848 OGGIONO (LC)
 Tel. 0341 578960 - Fax 0341 263053

PROGETTO: ARROTOLA MATERASSI	
CLIENTE: BROSIO	
COMMESSA: BM183	
TITOLO: Ingressi e uscite In Out	
DIS.: FIB	DATA: 14/05/2014

Omron

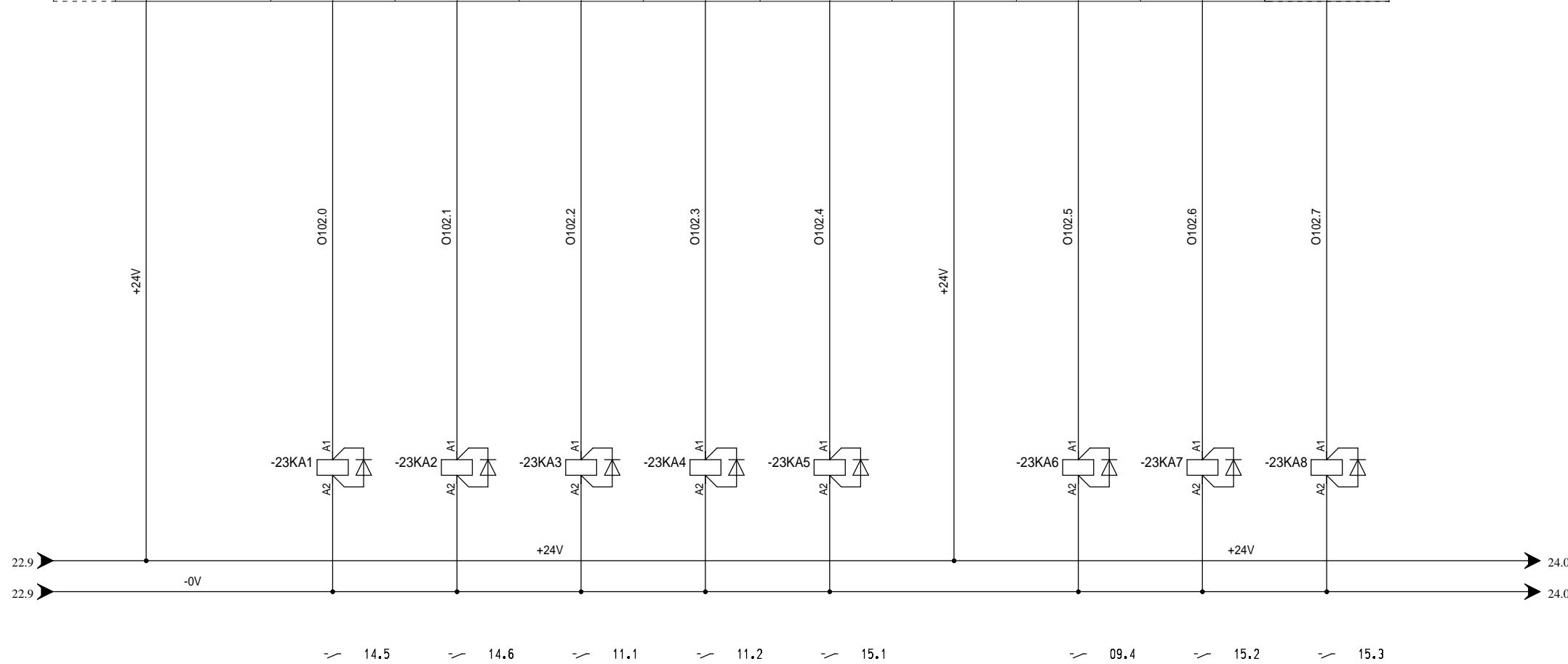
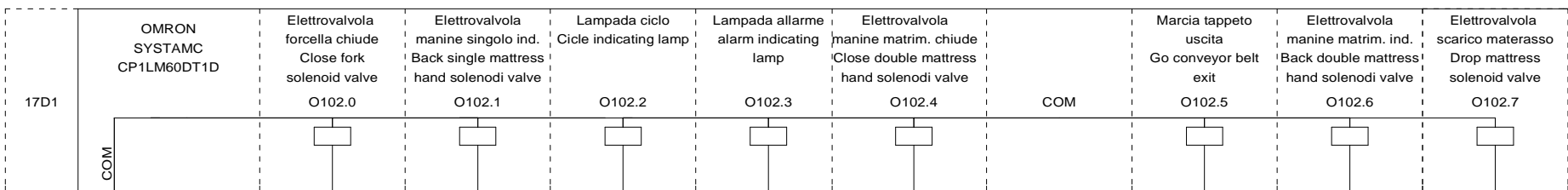

14.5 14.6 11.1 11.2 15.1 09.4 15.2 15.3

REV.	DATA	FIRMA	MODIFICA

FIB Srl **Forniture Industriali Brianza**
 Via Altobello 9/11
 23848 OGGIONO (LC)
 Tel. 0341 578960 - Fax 0341 263053

PROGETTO: ARROTOLA MATERASSI	
CLIENTE: BROSIO	
COMMESSA: BM183	
TITOLO: Ingressi e uscite In Out	
DIS.: FIB	DATA: 14/05/2014

FOGLIO 23
 DI 33
 22 ◀ ▶ 24

Omron

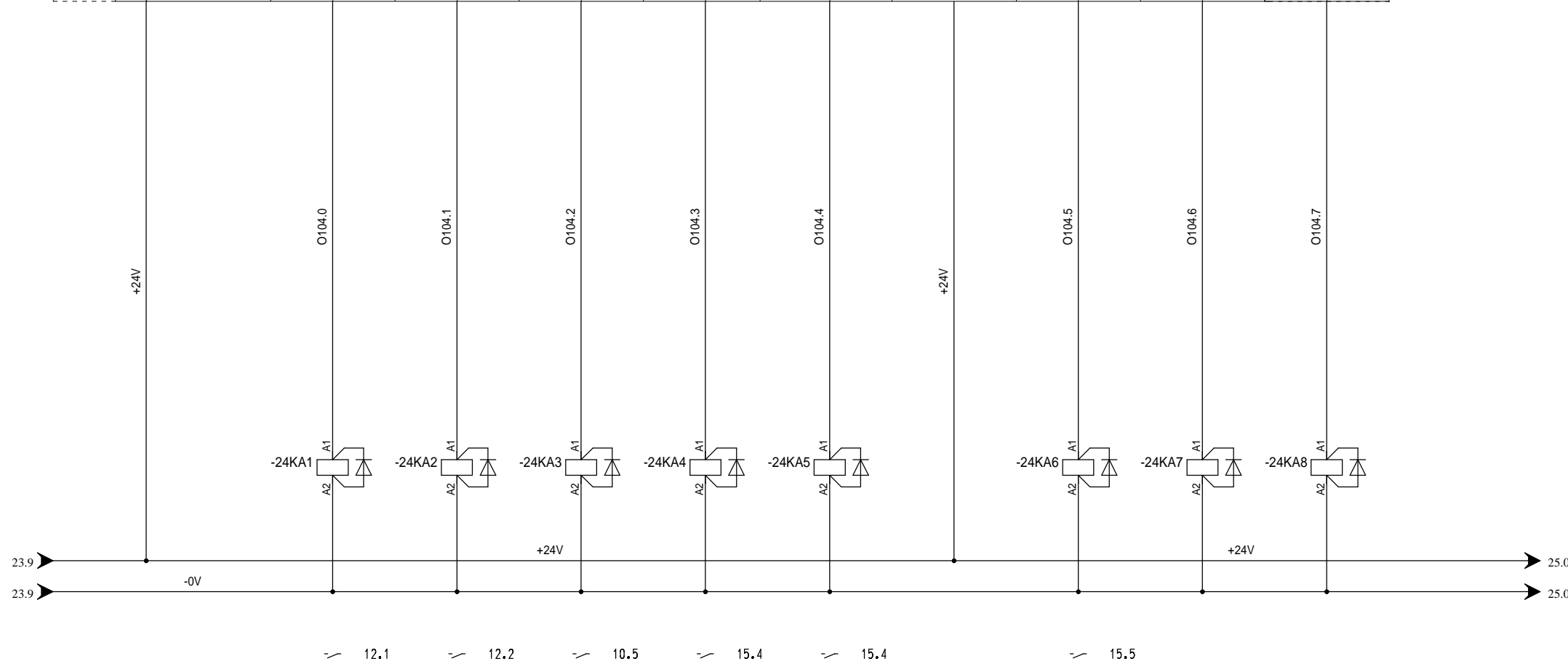
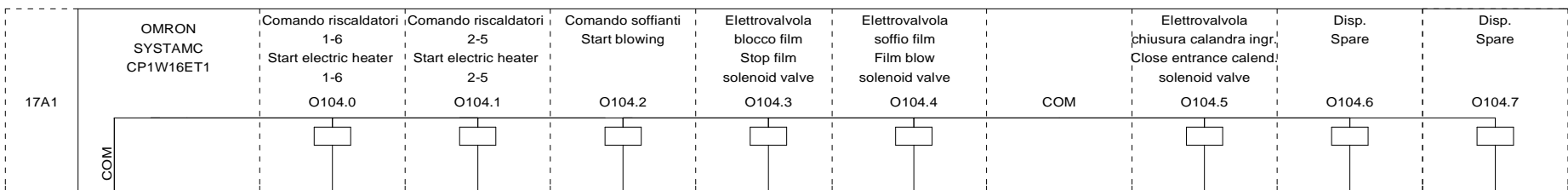

12.1 12.2 10.5 15.4 15.4 15.5

REV.	DATA	FIRMA	MODIFICA

FIB Srl **Forniture Industriali Brianza**
 Via Altobello 9/11
 23848 OGGIONO (LC)
 Tel. 0341 578960 - Fax 0341 263053

PROGETTO: ARROTOLA MATERASSI	
CLIENTE: BROSIO	
COMMESSA: BM183	
TITOLO: Uscite Exp Exp Out	
DIS.: FIB	DATA: 14/05/2014

FOGLIO 24
 DI 33
 23 ◀▶ 25

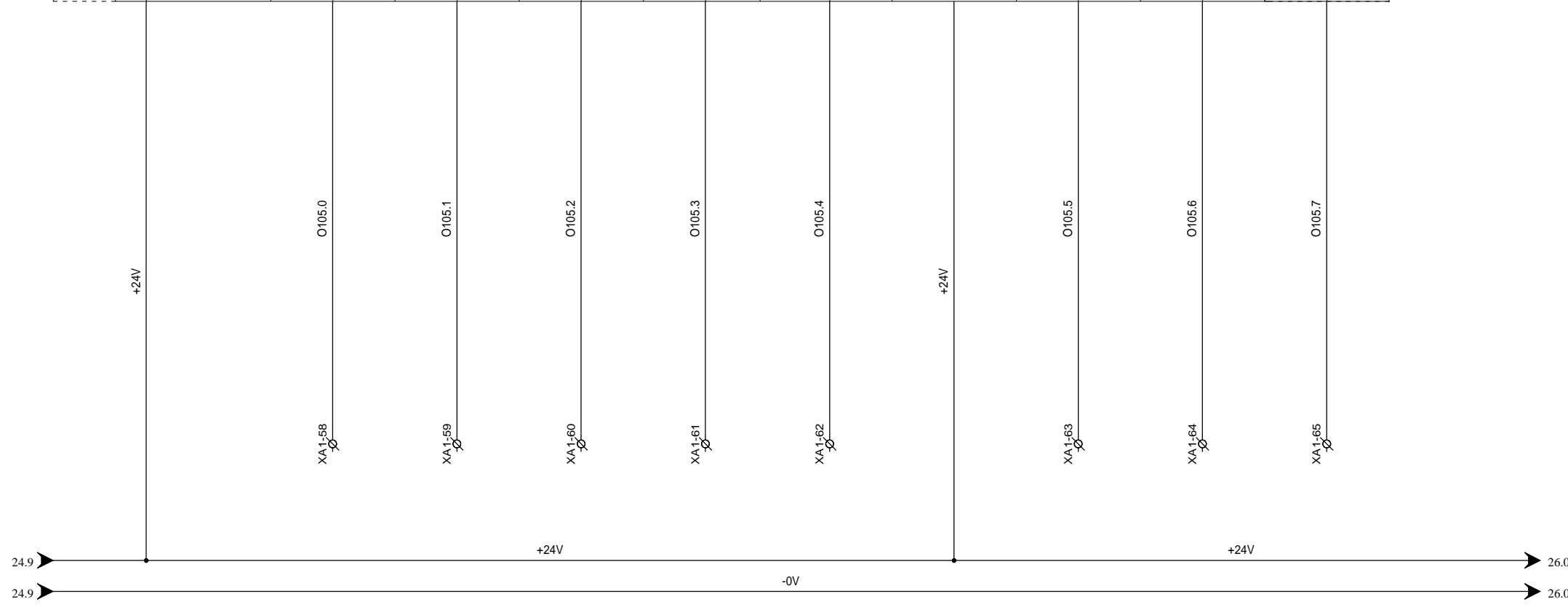
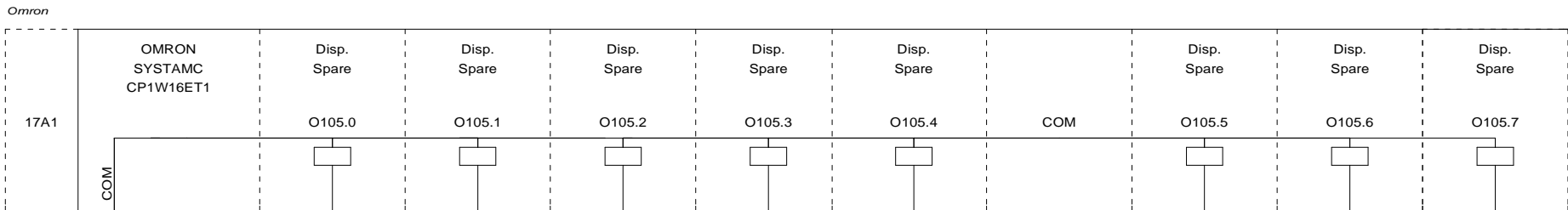

REV.	DATA	FIRMA	MODIFICA

FIB Srl **Forniture Industriali Brianza**
 Via Altobello 9/11
 23848 OGGIONO (LC)
 Tel. 0341 578960 - Fax 0341 263053

PROGETTO: ARROTOLA MATERASSI	
CLIENTE: BROSIO	
COMMESSA: BM183	
TITOLO: Uscite Exp Exp Out	
DIS.: FIB	DATA: 14/05/2014

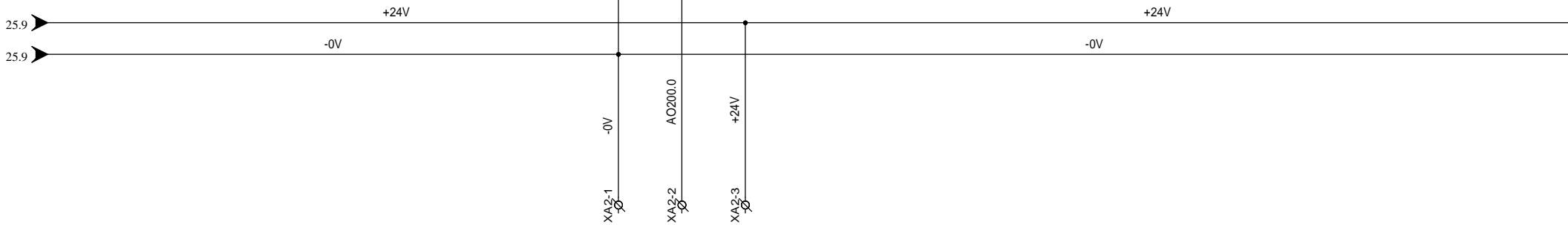
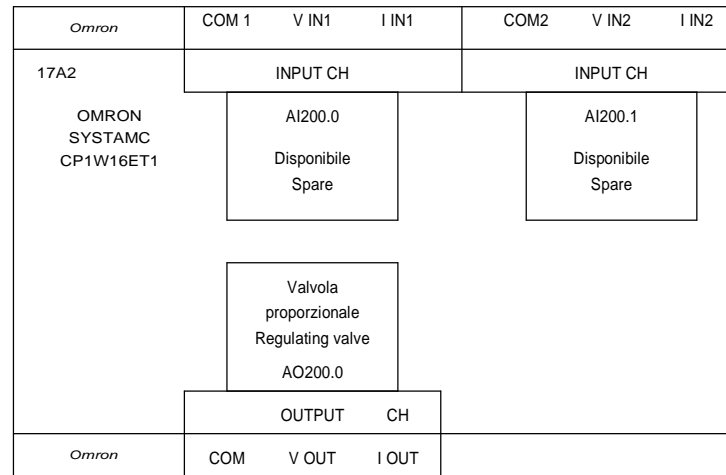

REV.	DATA	FIRMA	MODIFICA

FIB Srl **Forniture Industriali Brianza**
 Via Altobello 9/11
 23848 OGGIONO (LC)
 Tel. 0341 578960 - Fax 0341 263053

PROGETTO: ARROTOLA MATERASSI	
CLIENTE: BROSIO	
COMMESSA: BM183	
TITOLO: Uscite analog. Exp Exp Out analog	
DIS.: FIB	DATA: 14/05/2014

DESCRIZIONE

SOFFIANTE RISCALDATORE
ELECTRIC HEATRE BLOWING MACHINE
SOFFIANTE RISCALDATORE
ELECTRIC HEATRE BLOWING MACHINE
SOFFIANTE RISCALDATORE
ELECTRIC HEATRE BLOWING MACHINE
SOFFIANTE RISCALDATORE
ELECTRIC HEATRE BLOWING MACHINE

DESTIN.

10M1
10M1
10M1
10M1

M1

FILO

PIASTRA TERMINALE

U4
V4
W4

PIASTRA TERMINALE

ORIGINE

DESCRIZIONE

REV.	DATA	FIRMA	MODIFICA

FIB

Srl

Forniture Industriali Brianza

Via Altobello 9/11

23848 OGGIONO (LC)

Tel. 0341 578960 - Fax 0341 263053

PROGETTO: ARROTOLA MATERASSI

CLIENTE: BROSIO

COMMESSA: BM183

TITOLO: Morsettiere: M1
M1 - 1/1

DIS.: FIB

DATA: 14/05/2014

FOGLIO 1

DI 33

◀▶2

XA2

DESTIN.	FILO	MORSETTO	ORIGINE
	PIASTRA TERMINALE		
	-0V	1	
	AO200.0	2	
	+24V	3	
	PIASTRA TERMINALE		

DESCRIZIONE

DESCRIZIONE

REV.	DATA	FIRMA	MODIFICA

FIB Srl **Forniture Industriali Brianza**
 Via Altobello 9/11
 23848 OGGIONO (LC)
 Tel. 0341 578960 - Fax 0341 263053

PROGETTO: ARROTOLA MATERASSI	
CLIENTE: BROSIO	
COMMESSA: BM183	
TITOLO: Morsettiere: XA2	
XA2 - 1/1	
DIS.: FIB	DATA: 14/05/2014

FOGLIO **5**
 DI **33**

XP1

DESCRIZIONE	DESTIN.	FILO	MORSETTO	ORIGINE	DESCRIZIONE
		PIASTRA TERMINALE	Ø		
		R-1	Ø	12KM1	
		N-1	Ø	12KM1	
		S-2	Ø	12KM2	
		N-2	Ø	12KM2	
	07M1	U1	Ø		MOTORE ROTAZIONE CILINDRO
	07M1	V1	Ø		CILINDER ROTATION MOTOR
	07M1	W1	Ø		MOTORE ROTAZIONE CILINDRO
	08M1	U2	Ø		CILINDER ROTATION MOTOR
	09M2	PE	Ø		MOTORE ESPULSIONE CILINDRO
	08M1	V2	Ø		CILINDER EJECTION ROTATION
	08M1	W2	Ø		MOTORE ESPULSIONE CILINDRO
	09M1	U3	Ø		CILINDER EJECTION ROTATION
	07M1	PE1	Ø		MOTORE TAPPETO USCITA
	09M1	V3	Ø		BELT CONVEJOR MOTOR
	09M1	W3	Ø		MOTORE TAPPETO USCITA
	09M2	U3A	Ø		BELT CONVEJOR MOTOR
	08M1	PE2	Ø		MOTORE TAPPETO USCITA
	09M2	V3A	Ø		MOTORE ESPULSIONE CILINDRO
	09M2	W3A	Ø		CILINDER EJECTION ROTATION
	09M1	PE3	Ø		MOTORE TAPPETO USCITA
		PIASTRA TERMINALE	Ø		BELT CONVEJOR MOTOR

REV.	DATA	FIRMA	MODIFICA

FIB Srl **Forniture Industriali Brianza**
 Via Altobello 9/11
 23848 OGGIONO (LC)
 Tel. 0341 578960 - Fax 0341 263053

PROGETTO: ARROTOLA MATERASSI	
CLIENTE: BROSIO	
COMMESSA: BM183	
TITOLO: Morsettiara: XP1 XP1 - 1/1	
DIS.: FIB	DATA: 14/05/2014